

EBDSPIR-PRM-L3

Ceiling PIR presence detector with 3m pre-wired lead

Overview



The EBDSPIR-PRM-L3 PIR (passive infrared) presence detector provides automatic control of lighting loads.

The output channel comprises a mains voltage relay capable of simple on/off switching.

Functioning as a presence detector, the unit can turn lights on when a room is occupied and off when the room is empty. Optional settings allow lights to be turned off in response to ambient daylight.

All functionality is fully programmable using an IR handset.

Features

Front features

Mounting Bezel

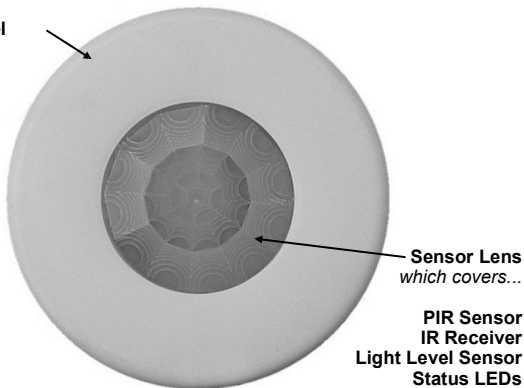

PIR Sensor

Detects movement within the unit's detection range, allowing load control in response to changes in occupancy.

IR Receiver



Receives control and programming commands from an IR (infrared) handset.

Light Level Sensor

Measures the overall light level in the detection area

Status LEDs

The LED flashes Red to indicate the following:

Walk Test LED active	 when movement is detected
Valid setting received	

Detection diagram

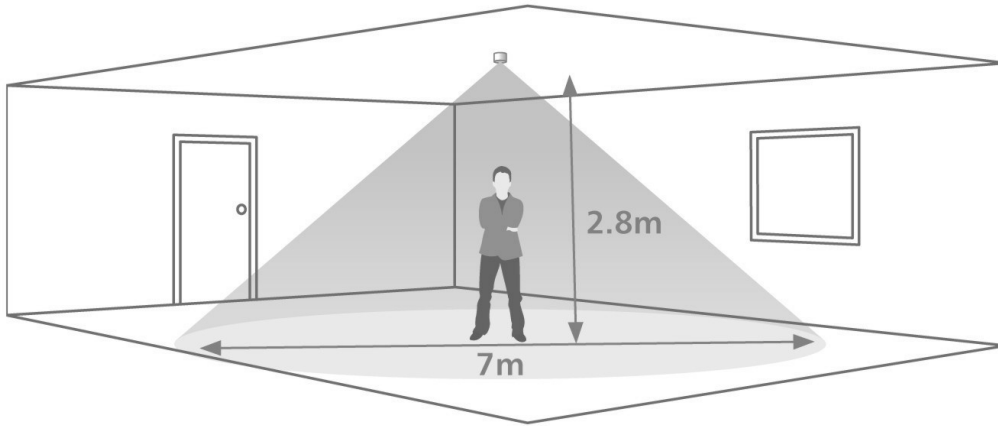

Area of high sensitivity  Area of lower sensitivity

Installation

Choosing a Suitable Location

The EBDSPiR-PRM is designed to be ceiling mounted and must satisfy the following criteria:

- Avoid positioning the unit where direct sunlight may enter the sensor element.
- Do not site the sensor within 1m of any lighting, forced air heating or ventilation.
- Do not fix the sensor to an unstable or vibrating surface.

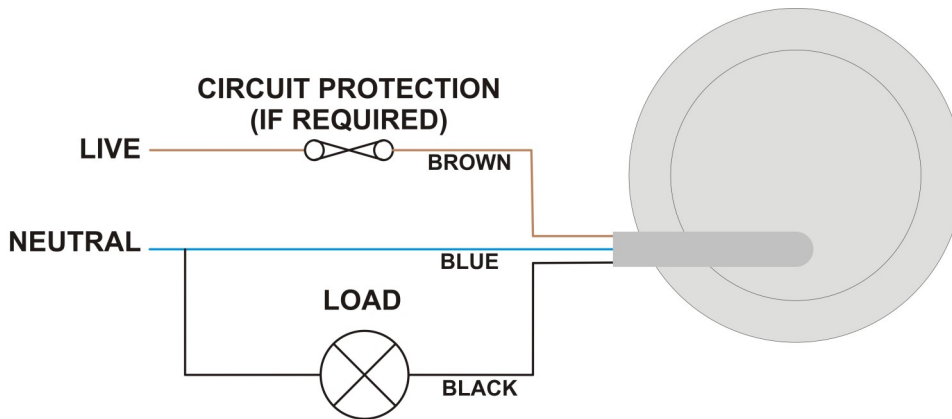

Power-up test procedure

When power is applied to the unit, the load will turn on immediately.

Set the timeout to 10 seconds, vacate the room or remain very still and wait for the load to switch off .

Check that the load switches on when movement is detected.

The unit is now ready for programming.

Sensor functionality

Presence detection

- When movement is detected the load will automatically turn on. When the area is no longer occupied the load will automatically switch off after an adjustable time period.

In either case, sensitivity to movement of the PIR sensor can be adjusted using the Sensitivity parameter.

HINT: To assist in setting the Sensitivity, turn on the Walk Test LED which will flash red when movement is detected.

Switch Level On/Off

Occupancy detection can be made dependant on the ambient light level using the Lux On Level and Lux Off Level parameters.

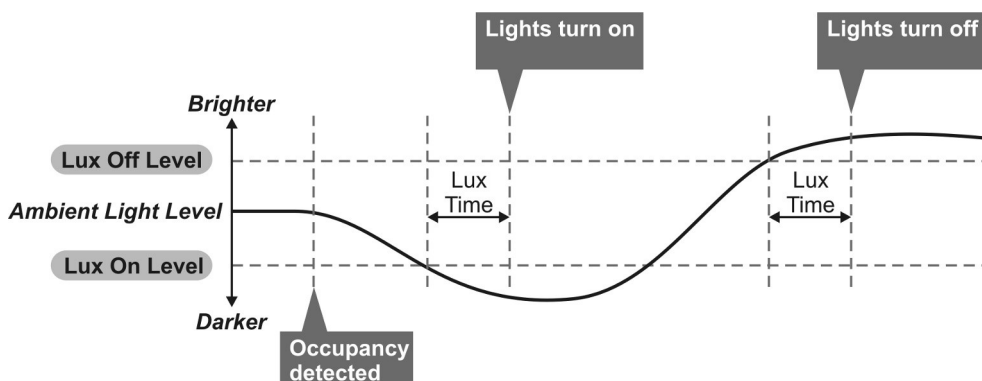

Installation

The EBDSPiR-PRM-L3 is designed to be mounted using either:

- Flush fixing, or
- Surface fixing, using the optional Surface Mounting Box (part no. DBB).

Both methods are illustrated below.

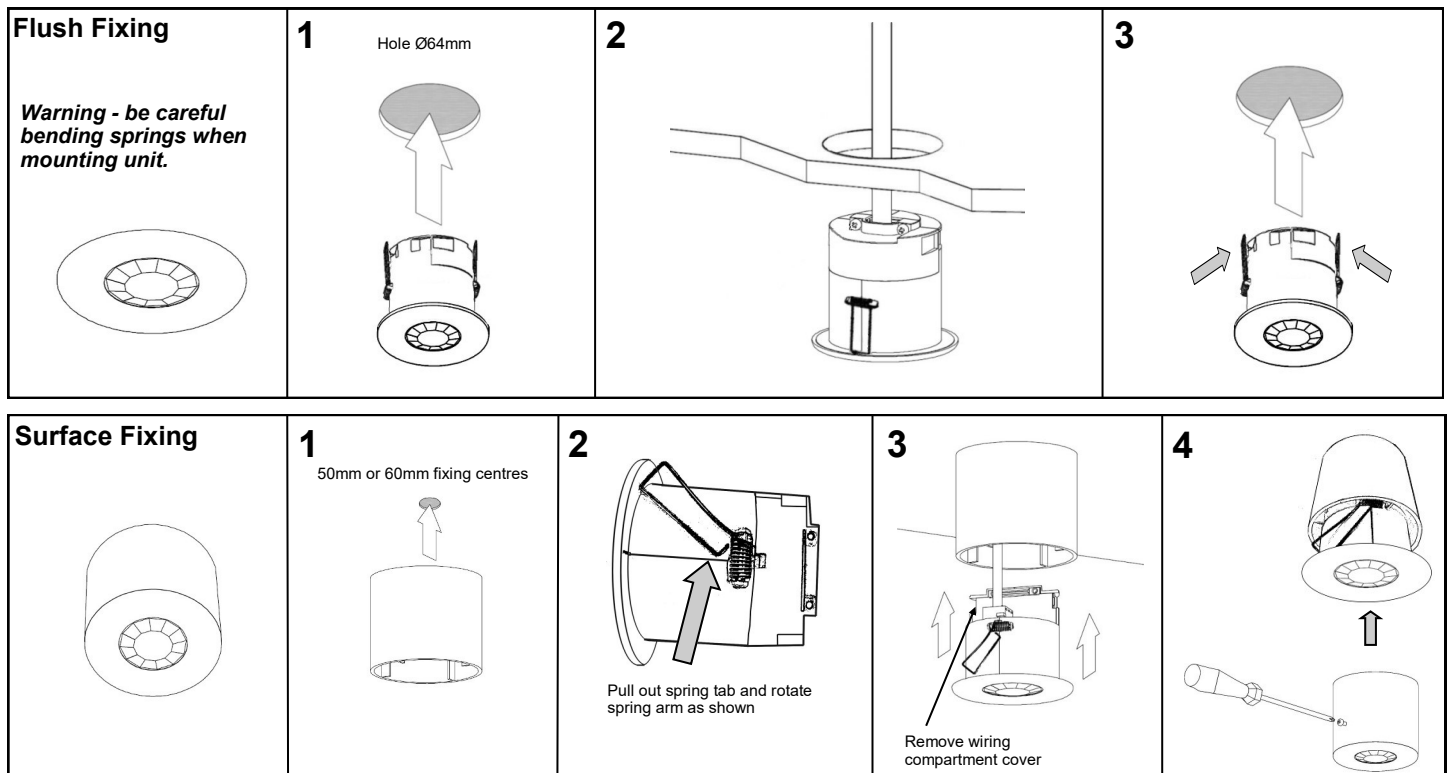

Readback function (UNLCDHS handset only)

The UNLCDHS has the ability to read back the settings stored in a device.

To read back individual parameters

- Navigate to the parameter and press the 'R' (Read) button whilst pointing at the device. The handset will click when the parameter has been read back, the device will flash its LED, and the value will be shown against the parameter in the menu.

To read back all of the parameters in a menu

- Press and hold the 'R' (Read) button for more than 1 second.
- The handset will click every time a parameter is received
- The device will show multiple flashes of its LED
- All of the values will be shown against the parameters in the menu.
- The individual parameters may be edited and then saved as a 'Macro'.

Notes

- If a parameter(s) has been missed because of a communication error, the missing value(s) is replaced by dashes.
- When reading back, the relay will temporarily be switched off, and will return to its normal state 2 seconds after the read back has been completed.

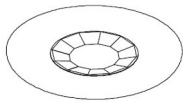

The functionality of the EBDSPiR-PRM-L3 is controlled by a number of parameters which can be changed or programmed by any of the following devices:

- **UHS5** Infrared Handset. See below for programmable functions.
- **UNLCDHS** Infrared Handset (with LCD). See user guide for full programming details.

For most basic programming operations the UHS5 handset can be used and the following procedures are based on using this device.

Point the handset at the Sensor and send the required programming commands to the unit as shown below.

Valid commands will be indicated by a red LED flash. See page 1 for details of other LED responses.

Note: other functions on the UHS5 which are not shown below are not applicable to this product.

Parameter Name	Default Value	Number of Shift key presses				UHS5 Handset Graphics	Description
		0 SHIFT 1 SHIFT 2	1 SHIFT 1 SHIFT 2	2 SHIFT 1 SHIFT 2	3 SHIFT 1 SHIFT 2		
Button Activation							
On		On					Turn lights on.
Off		Off					Turn lights off.
Walk test	Off	On	Off				When set to On this causes a red LED to flash on the sensor when it detects movement. Use this feature to check for adequate sensitivity levels.
Time Out (Time adjustment)	20 mins	1, 10 & 20 minutes	5, 15 & 30 minutes	10 seconds			Once the detector is turned on, this value sets how long the lights will stay on once movement has ceased.
Lux on level (Switch level on)	9	2, 5 & 7	4, 6 & 9				Lux level setting to prevent the luminaires being switched on if the ambient light level is sufficient (adjustable between 1 and 9). The luminaires will always be switched on at level 9.
Lux off level (Switch level off)	9	2, 5 & 7	4, 6 & 9				Lux level setting to switch the luminaires off during occupancy if the ambient light level goes above the setting (adjustable between 1 and 9). Level 9 will always keep the lights on. This setting can be used for "window row switching". <i>Note: the Lux Off Level value must always be greater than the Lux On Level value.</i>
Sensitivity	9	1, 5 & 9	3, 6 & 8				Sensitivity level for detecting movement. 1 = low sensitivity 9 = high sensitivity
Defaults				D			Returns the unit to the default settings.
Shift							Use this button to select the settings in red and blue signified by the 'Shift 1' and 'Shift 2' LEDs

Fault finding

What if the load does not turn ON?

- Check that the live supply to the circuit is good.
- Check that the load is functioning by bypassing the sensor (e.g. link terminals **L** and **L/ Out** on Channel1).
- If the detection range is smaller than expected, check the diagram on page 2. Rotating the sensor slightly may improve the detection range.

HINT: The Walk Test LED function can be used to check that the unit is detecting movement in the required area.

What if the load does not turn OFF?

- Ensure that the area is left unoccupied for longer than the Time Out Period.
- Ensure that the sensor is not adjacent to circulating air, heaters or lamps.

Advanced programming

Parameter Name	Default Value	Range / Options	Description	UHS5	UNLCDHS
Detector Parameters					
Walk Test LED	Off	On or Off	When set to On this causes a red LED to flash on the sensor when it detects movement. Use this feature to check for adequate sensitivity levels.	✓	✓
Time Out (Time adjustment)	20 minutes	0-99 minutes	Once the detector is turned on, this value sets how long the lights will stay on once movement has ceased. Select 0 for 10 second delay – use for commissioning only.	✓	✓
Manual Time Out	10 minutes	0-99 minutes	When a manual operation occurs, either via the switch input or the infrared, it invokes the timeout period. Example 1: a detector in presence mode has a detector timeout of 15 minutes and a manual timeout of 3 minutes. When the user leaves the room they press the off button. The sensor will revert to automatic after 3 minutes, and then walking back in the room will turn the lights on. Example 2: using the settings above, the user turns the lights off (say for a presentation) but stays in the room. Every time a movement is detected, the manual timeout period is re-triggered, but when it doesn't pick up for the short timeout period, the sensor will timeout and revert to automatic. This means the lights may turn on inadvertently during the presentation, if the occupants are still for the manual timeout period, so adjust the timing carefully.	✗	✓
Sensitivity On	9	1 (min) to 9 (max)	Sensitivity level for detecting movement when the detector is already on. *UHS5 sets Sensitivity On and Off to the same value.	✓*	✓
Sensitivity Off	9	1 (min) to 9 (max)	Sensitivity level for detecting movement when the detector is off. *UHS5 sets Sensitivity On and Off to the same value.	✓*	✓
Lux time	0	0 (disabled) 1-99 minutes	If the detector measures the lux level and decides that the output needs switching on or off as a consequence, the lux time must elapse first. If at any time during the timed delay the lux change reverses then the process is cancelled.	✗	✓
Power Up State	On	On or Off	Select No for a 30 second delay on start up. If Yes is selected, there will be no delay on start up and the detector will always power up detecting.	✗	✓
Inhibit	4 seconds	1 to 999 seconds	When the detector turns off, a delay is instigated to prevent retriggering. In certain circumstances this delay may not be enough. This parameter allows the delay to be changed.	✗	✓
Factory default	-	-	Restores factory default settings	✓	✓

Switching functions					
Lux on level (Switch level on)	9	1 to 9 For a higher resolution a scale of 101-199 is available	Sets a minimum light level below which the PIR sensor is enabled, allowing lights to be turned on by movement. <i>Note: the Lux Level Off value must always be greater than the Lux Level On value.</i>	✓	✓
Lux off level (Switch level off)	9	1 to 9 For a higher resolution a scale of 101-199 is available	Sets a maximum light level above which the PIR sensor is disabled, preventing lights from being turned on by movement.	✓	✓

User Modes					
Override On	-	-	If the lights are off, sending the IR command will turn them on immediately and revert to automatic operation using the manual timeout period .	✓	✓
Override Off	-	-	If the lights are on, sending the IR command will turn them off immediately. After the manual timeout period (described above), the sensor will revert to automatic.	✓	✓
Cancel	-	-	Cancels the on or off override, returning the detector to normal operation.	✗	✓

This page intentionally left blank

Technical data

Dimensions	See diagrams opposite
Weight	0.4kg
Supply Voltage	230VAC +/- 10%
Frequency	50Hz
Maximum Load	10A of lighting and/or ventilation including incandescent, fluorescent, compact fluorescent, low voltage (by switching the primary of transformer).
Power consumption	On 875mW, Off 895mW
Temperature	-10°C to 35°C
Humidity	5 to 95% non-condensing
Material (casing)	Flame retardant ABS and PC/ABS
Type	Class 2
IP rating	IP40

Compliance EMC-2014/30/EU
LVD-2014/35/EU

For further compliance information visit
www.cpelectronics.co.uk/compliance



EBDSPIR-PRM

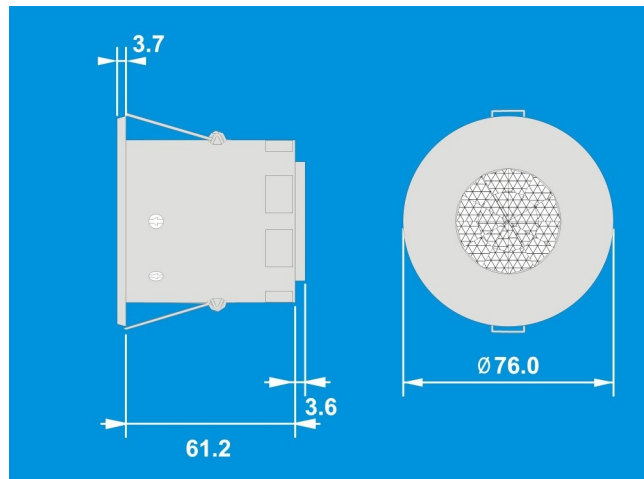

DBB

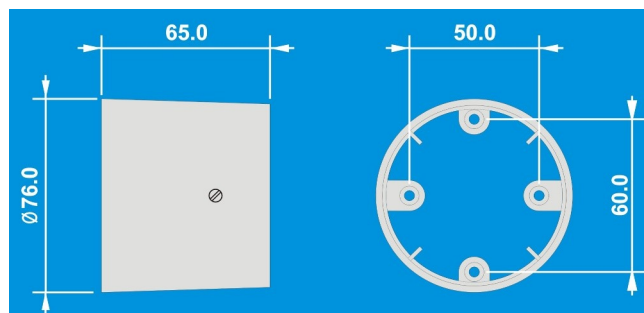

Part numbers

Detector	Part number	Description
	EBDSPIR-PRM-L3	Ceiling PIR presence detector with 3m pre-wired lead
Accessories	DBB	Surface mounting box
	UHS5	Programming IR handset
	UNLCDHS	Universal LCD IR handset

IMPORTANT NOTICE!

This device should be installed by a qualified electrician in accordance with the latest edition of the IEE Wiring Regulations and any applicable Building Regulations.



C.P. Electronics Ltd
Brent Crescent
London
NW10 7XR
United Kingdom
Tel: + 44 (0) 333 900 0671
Fax: + 44 (0) 333 900 0674
www.cpelectronics.co.uk
enquiry@cpelectronics.co.uk